

ADAPTIVE CONTROL OF SULPHUR RECOVERY UNITS

Dr. Bruce Wilson
Senior Control Engineer
Suncor
Fort McMurray, Alberta

Bill Gough
Research and Development Manager
Universal Dynamics Technologies Inc.
Richmond, British Columbia

John Kay
President
Universal Dynamics Technologies Inc.
Richmond, British Columbia

ABSTRACT

Sulphur is a major component in the waste gases produced during the oil refining process. Efficient sulphur recovery is very important to the operation of an oil refinery due to environmental legislation that restricts total sulphur emissions from the plant. Optimum control of the sulphur recovery units (SRUs) is difficult to achieve with conventional controllers due to variations in waste gas composition and inherent time delays in the sulphur recovery process.

This paper describes the application of a unique minimum effort adaptive controller (AC) to the sulphur recovery process at an oil refinery. The ability of this controller to continuously adapt to changing process conditions and time delays and the ability to incorporate adaptive compensation resulted in improved control of the SRU and a significant increase in sulphur recovery efficiency compared to the existing distributed control system (DCS) based control strategy.

INTRODUCTION

Sulphur recovery is an integral part of the oil refining process. Elemental sulphur is recovered from various waste gas streams, which are byproducts of plant operation using Sulphur Recovery Units (SRUs). Environmental legislation imposes limits on the total quantity of sulphur compounds, such as hydrogen sulphide (H_2S) and sulphur dioxide (SO_2), which can be expelled from the plant. Typically each oil refinery operates with a license that specifies the permitted sulphur emission limits.

Environmental legislation is expected to continue to increase the restrictions on sulphur emissions for the petrochemical industry. It is essential that the existing sulphur recovery equipment be operated at maximum efficiency to avoid expensive equipment modifications or possible production curtailments in order to meet the sulphur emission limits.

Improved process control is an economical alternative to increase sulphur recovery efficiency. The most critical factor affecting the efficiency is the level of excess oxygen (trim air) introduced at the first stage of the SRU. This is a difficult parameter to control accurately because of the long time delay between a change in trim air at the first stage of the SRU and the measured result at the last stage of the SRU. In addition, the composition of the waste gas streams change continuously and thus change the required quantity of excess oxygen.

Adaptive controllers are well suited to the control problems found on SRUs as they are able to handle the long process time delays inherent in the process as well as continuously adapt to changing process conditions in order to automatically maintain optimum performance.

This paper will briefly review adaptive control strategies that exist today and will then explain the novel approach that we have used to develop a "minimum effort" adaptive controller (AC) that has been successfully applied in a variety of industries. The sulphur recovery process and the related control problems will be discussed and the results of our field trial on the SRU will be presented.

ADAPTIVE CONTROLLER DEVELOPMENT

Adaptive Control

Adaptive control schemes provide the opportunity to achieve improved control performance by basing the control action on a mathematical model of the process, including time delay, that is used to forecast process response and subsequently calculate the actual control action required to obtain set point. The mathematical model is adjusted automatically to compensate for changes in the process characteristics so that the controller can maintain control under various operating conditions. Commercially produced controllers of this type have commonly been called "model based" adaptive controllers.

These schemes rely on the creation of an exact mathematical model of the process for each application of the controller. This requires a detailed knowledge of the transfer function (plant order, time constants, time delay), usually determined experimentally, before it is possible to implement the controller. This requirement limits the ability to transfer a single controller design from one process to another.

Adaptive controllers are used extensively in aircraft and naval auto-pilots. The time invested to develop accurate mathematical models for these systems can be justified because the models can be re-used on a number of identical aircraft or ships. Until now, commercially available adaptive controllers for use in industry have been based on general process models that do not always adequately represent the individual process characteristics. The degree to which the simplified model is able to represent the actual transfer function determines the accuracy of the calculated control actions and the resulting performance. These controllers are usually difficult to apply and have had varying degrees of success.

A New Approach to Adaptive Control

The minimum effort adaptive controller (AC) is a breakthrough in adaptive control based on new theory developed by Dr. Guy Dumont and Dr. Chris Zervos at the University of British Columbia. ^[1] The unique feature of this scheme is the ease of implementation compared to the model based methods employed by previous designs.

The advantage of this approach is that it does not require a predetermined model of the process to be controlled. The use of orthogonal functions to model the process permits rapid transfer function identification with a minimum of prior process information. The controller is able to learn the process transfer function while it is controlling the process and is able to automatically adapt to changes in gain, time constants or time delay to maintain optimal control. This same technique is used to learn the effects of measured process disturbances in order to incorporate adaptive feed forward compensation into the control strategy resulting in further performance improvements.

The AC uses its mathematical models of the process to forecast process response so that set point is attained as rapidly as possible with little or no overshoot, using a minimum of control effort (actuator manipulation).

The basic algorithm steps used in the AC are shown in Figure 1.

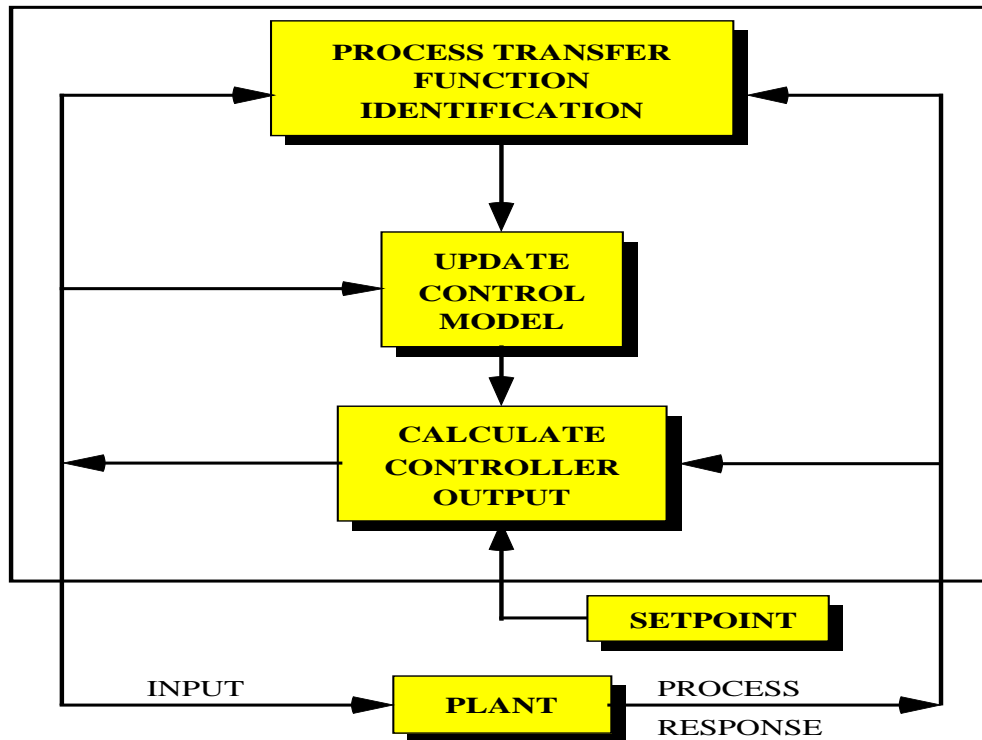

Figure 1. Basic Steps in the AC Controller

1. **Process Transfer Function Identification:** The process model is adjusted by relating observed process responses to past control actions.
2. **Control Update:** The previous control action is taken into account to produce a new prediction of future process response.
3. **Control Output:** The predicted process response is used to calculate the required controller output to bring the process variable to the desired set point with minimum control effort.

THE SULPHUR RECOVERY PROCESS

The oil refining process produces large quantities of waste gases with a high sulphur content. The sulphur must be recovered in order to meet environmental legislation that limits total sulphur emissions from the plant.

Suncor uses two parallel sulphur recovery units (SRU1 and SRU2) to process the Sour Water Stripper (SWS) acid gas and the Diethanol Amine (DEA) acid gas. Each SRU consists of a three-stage Claus process. The control objectives for this process are to maximize both capacity and sulphur recovery.

The main factors that affect sulphur recovery efficiency are the activation of the catalyst in the catalytic converter units and the level of excess oxygen introduced at the first stage of the SRU. A simplified schematic of the SRU, which details the excess oxygen control strategy, is shown in Figure 2.

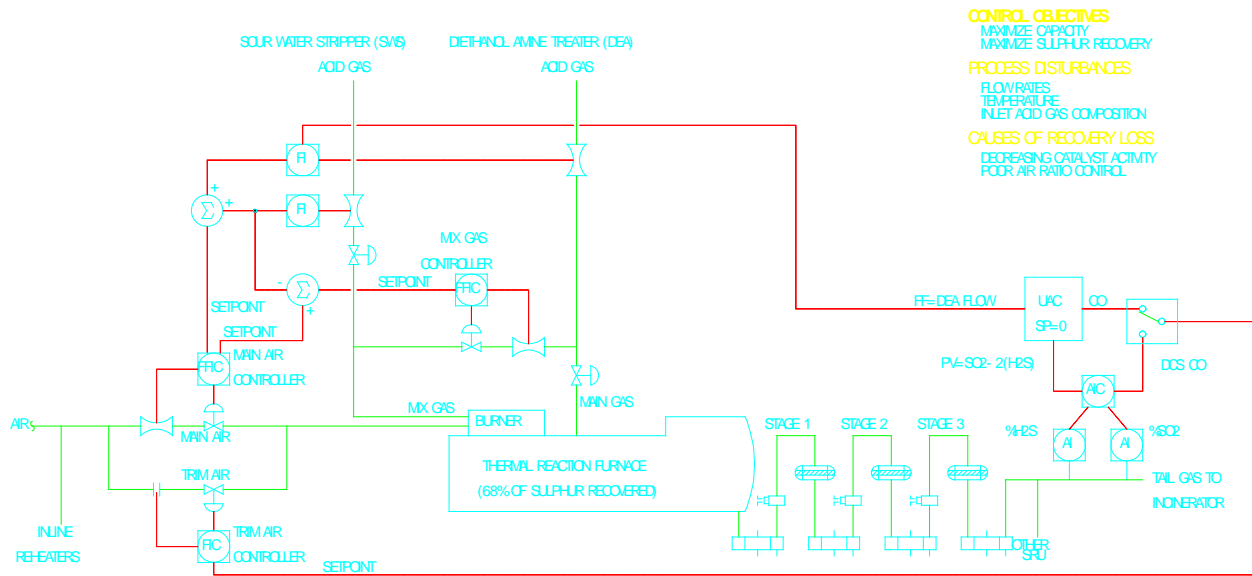
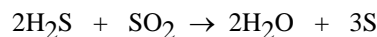

Figure 2. SRU Control Schematic

The first stage of the SRU is a thermal reaction furnace that recovers approximately 68% of the sulphur. The furnace is fired with the SWS acid gas. A portion of the DEA acid gas is mixed with the SWS acid gas in the burner (called mixed gas) in order to maintain a fixed mix gas:main gas ratio at the burner that results in a stable flame temperature. The remainder of the DEA acid gas (called main gas) reacts in the main chamber of the furnace with any remaining excess oxygen.

The outlet gases from the furnace are passed through a condenser, which condenses and removes elemental sulphur. The remaining gases are then passed through three stages of in-line re-heaters, catalytic converters, and condensers with each stage recovering 20 %, 8% and 2 % of the total sulphur respectively. The chemical reaction in the catalytic converters is:



Maximum sulphur recovery is obtained in the catalytic converters if the ratio of H₂S:SO₂ in the tail gas exiting the last converter is maintained at 2:1. The relationship between tail gas ratio control and sulphur recovery efficiency is graphed in Figure 3. This ratio is controlled by adjusting the excess oxygen in the first stage of the SRU in order to control the quantity of H₂S that is reacted to SO₂ in the furnace.

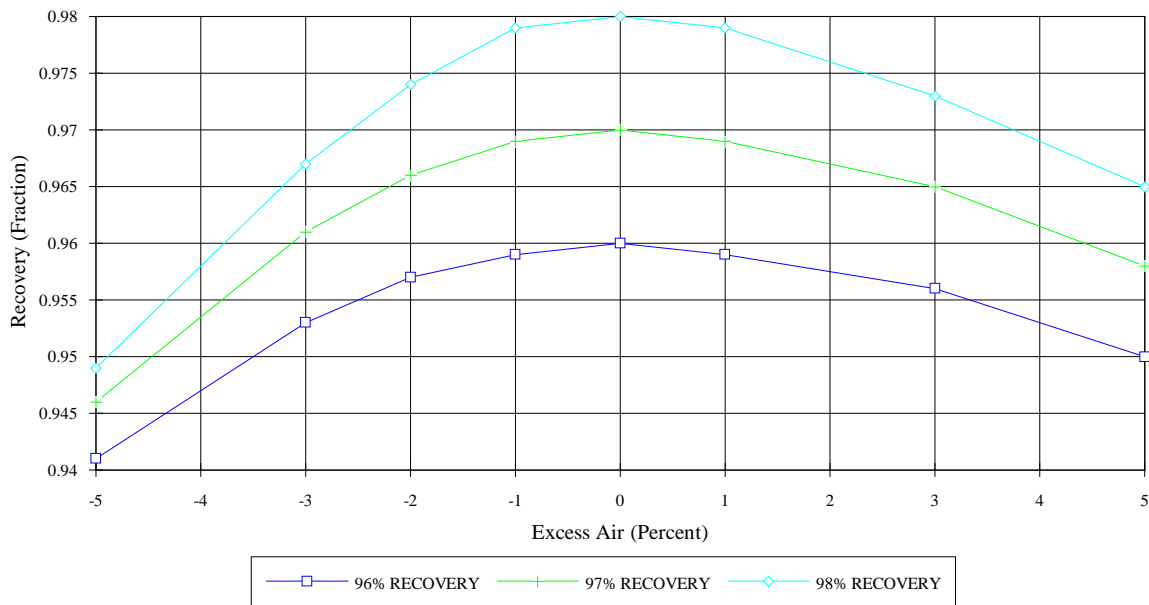

Figure 3. Effect of Tail Gas Ratio on Sulphur Recovery Efficiency

The excess oxygen control strategy is composed of a Main Air controller and a Trim Air controller. The Main Air controller adjusts the flow of combustion air to the reaction furnace to provide calculated feed forward (ratio) control of air to acid gas. The Trim Air controller uses a gas analyzer to determine the ratio of $H_2S:SO_2$ in the tail gas and performs feedback control of this ratio by adjusting excess oxygen.

It is difficult to control the tail gas ratio due to the following problems:

- 3 minute time delay between changes in excess oxygen and response of tail gas ratio,
- variations in SWS and DEA acid gas flow and chemical composition,
- high order, non-linear and time varying nature of the exothermic, catalytic reactions.

In addition, the SRU used for the adaptive controller test was operated on inlet acid gas back pressure control and as such was subject to large disturbances in DEA acid gas flow (i.e., SRU1 acid gas flows were regulated at the expense of SRU2). The adaptive feedforward capability of the AC was used to incorporate a measurement of the DEA acid gas flow into the control strategy.

TEST RESULTS

The performance of the existing DCS based tail gas ratio controller was recorded before and after the test run with the adaptive controller. A summary of the data collected during the test is presented in Table 1. Both the existing and the adaptive controller had periodic spikes caused by regular purging of the analyzer removed from the data as the values collected during the purge do not represent the actual tail gas ratio in the gas train.

Table 1. Comparison of SRU Control Performance

Date	Control	Standard Deviation	Comments
Oct 30-Nov 2/92	AC	0.30	
Nov 10-13/92	AC	0.38	* Worst performance
Nov 13-14/92	AC	0.30	
Nov 20-23/92	AC	0.24	
Nov 23-24/92	AC	0.28	
Nov 24-27/92	AC	0.23	
Nov 27-30/92	AC	0.22	*Best performance
	Weighted Average:	0.28	
Nov 30-Dec 1/92	DCS	0.41	
Dec 1-4/92	DCS	0.52	*Worst performance
Dec 4-7/92	DCS	0.40	*Best performance
	Weighted Average:	0.45	

The average standard deviation for the existing controller was 0.45 and the average standard deviation of the adaptive controller was 38 % lower at 0.28. Figure 4 shows the distribution of tail gas ratio values for both the best and worst DCS and adaptive controller data sets as indicated in Table 1. Note that the worst performance by the adaptive controller was still better than the best performance of the DCS controller. Figures 5 and 6 show data collected during a continuous six-day run for the DCS controller and Figures 7 and 8 show data collected for the adaptive controller, also over a continuous six day period.

The improved tail gas ratio control alone is estimated to have resulted in a 0.2 to 0.3% increase in sulphur recovery efficiency. Given the current limits shown in Table 2, this is a significant increase.

Table 2. Sulphur Emission Limits

Plant Size (t/d)	Required Efficiency (%)	Old Requirement (%)
2000 +	99.8	99.0
50 - 2000	98.5 - 98.8	96.2 - 98.8
10 - 50	96.2	92 - 96

Use of adaptive control on thermal reactor mix gas, mix gas temperature and catalytic converter temperature will improve efficiency still further. Optimized SRU operation through on-line instrument diagnosis, fault detection and automatic switching to backup control modes is accomplished by using expert system technology. The economic benefits to oil refineries and gas plants are obtained by avoiding production curtailments and environmental penalties for exceeding the sulphur emission license limits, as well as longer life for the catalyst beds, which are degraded when subjected to process disturbances.

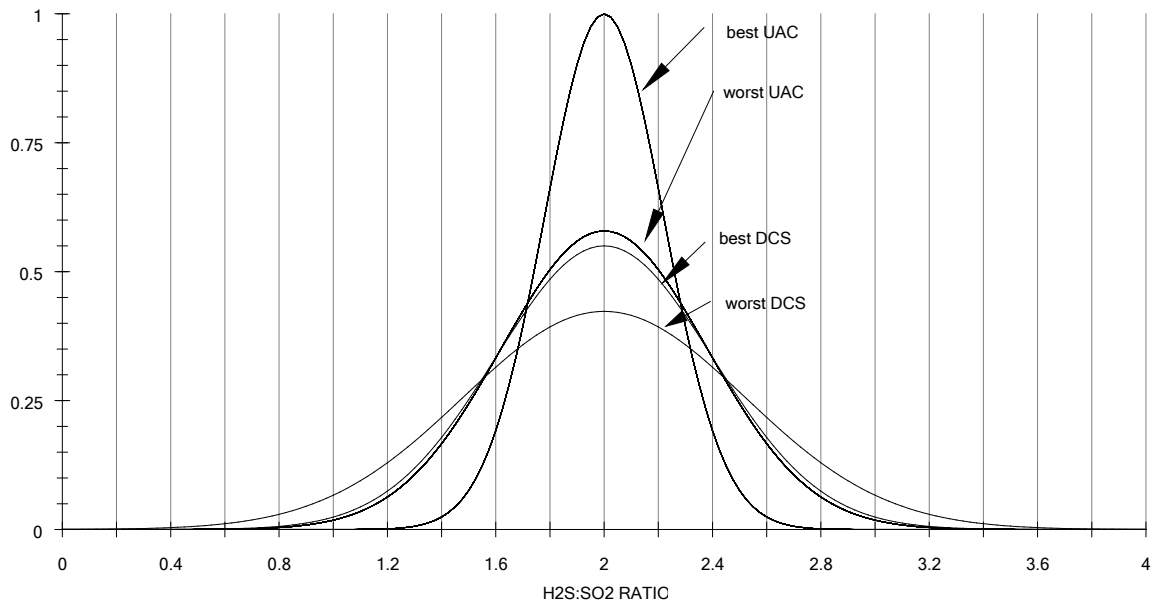

Figure 4. Comparison of Ratio Distribution (DCS vs UAC)

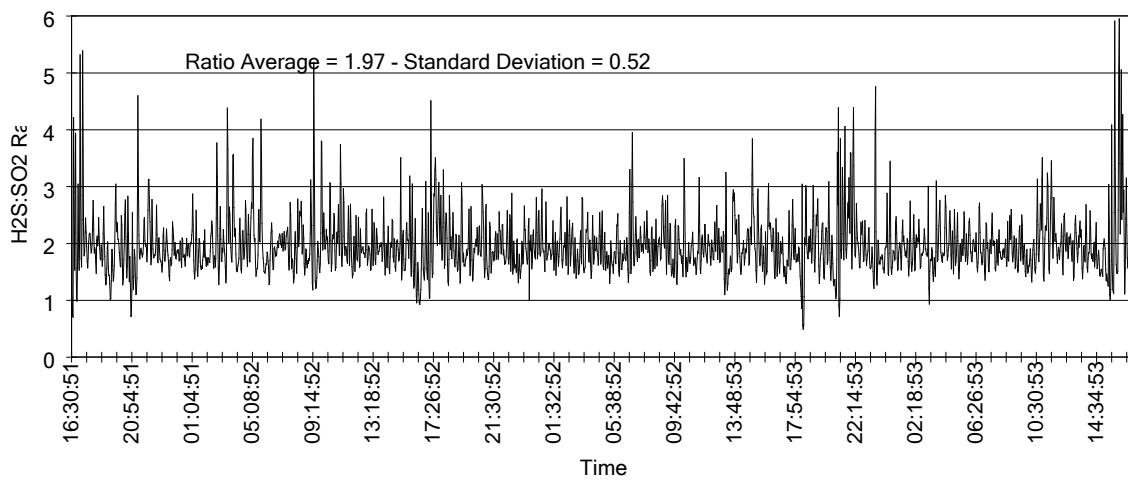

Figure 5. Existing Control (Dec. 1-4, 1992)

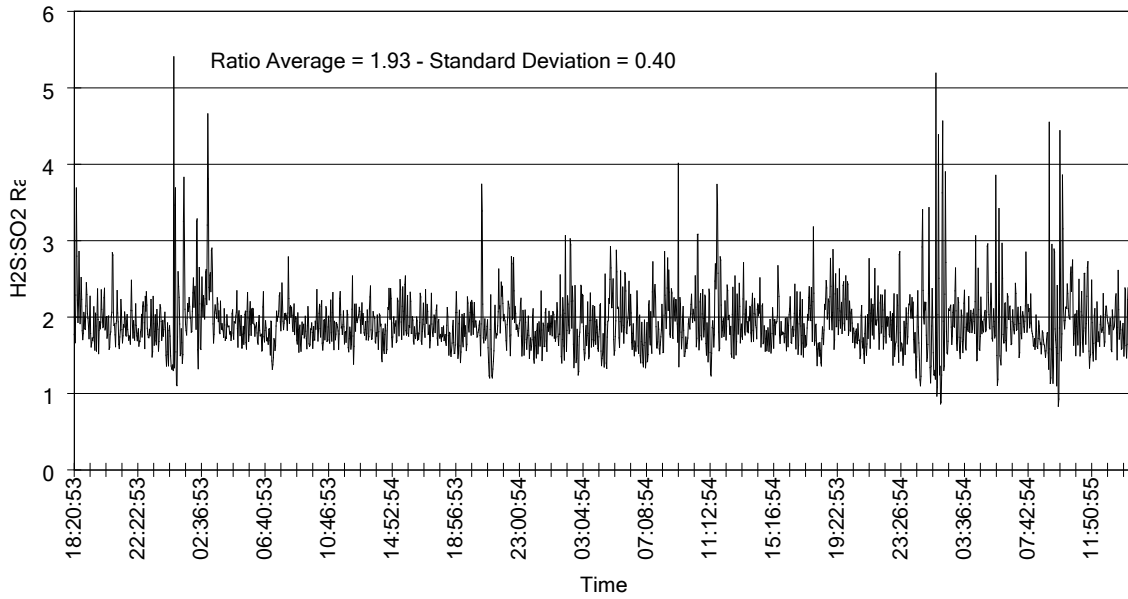

Figure 6. Existing Control (Dec 4-7, 1992)

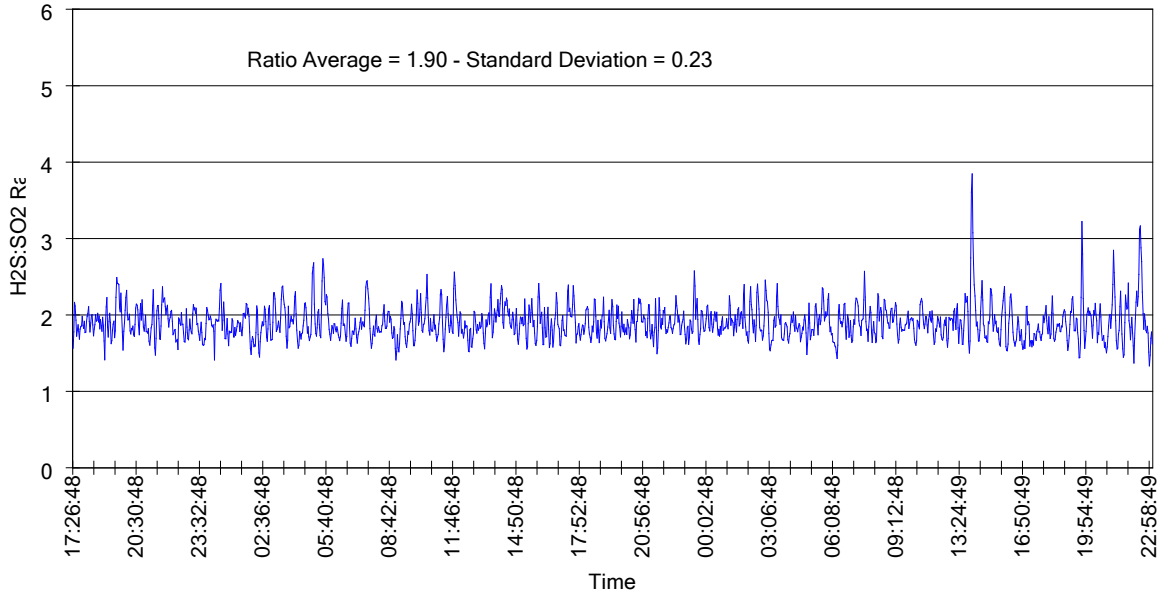

Figure 7. Adaptive Control (Nov 24-27, 1992)

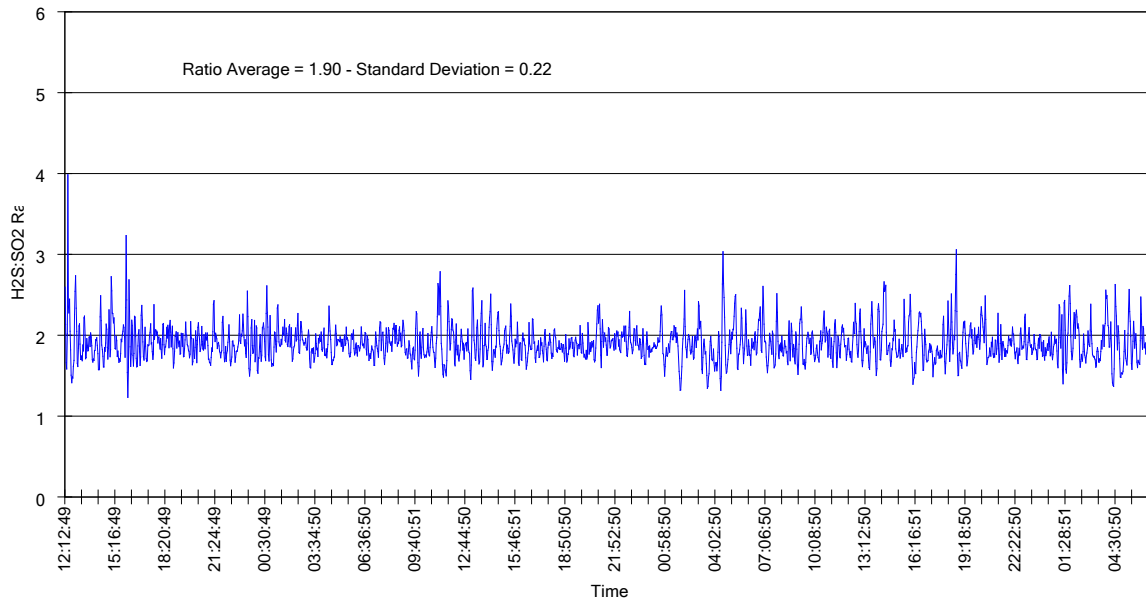

Figure 8. Adaptive Control (Nov 27-30, 1992)

CONCLUSIONS

The application of a new, innovative adaptive controller to the sulphur recovery process has resulted in a 38% reduction in SRU tail gas $H_2S:SO_2$ ratio standard deviation. This control improvement represents a considerable economic benefit to oil refineries and gas processing plants, particularly when compared to the costs of equipment modifications required to achieve the same improvement in sulphur recovery efficiency. In addition, the service life of the catalyst in the catalytic converter units is extended due to reduction of process disturbances, resulting in a lower operating cost.

The unique ability of this adaptive controller to learn the process and feedforward variable behavior automatically and continuously ensures optimum performance at all times. The problems of long development time, long setup time, repeated tuning and poor reliability associated with other advanced controllers are solved with this method.

The superior performance of this adaptive controller reduces process variability and enables the potential quality improvement benefits of supervisory and statistical process control systems to be realized. In addition, the cascade effects of many small improvements provided by tighter control on individual loops can improve the complete process or plant substantially. The AC is a new tool available to the process control engineer to implement the continuous improvement concepts advocated by Deming [2] and Juran [3] in their Total Quality philosophies.

REFERENCES

- [1] Zervos, C.C., and Dumont, G.A., "Deterministic adaptive control based on Laguerre series representation", *Int. J. Control*, Vol. 48, No. 6, pp. 2333-2359, 1988.
- [2] Deming, W.E., "Out of the Crisis", M.I.T. Center for Advanced Engineering Studies, 1989.
- [3] Juran, J.M., "Juran's Quality Control Handbook", McGraw-Hill, 1988.
- [4] Paskall, H.G. and James, J.A., "Sulphur Recovery", Bover Western Research Inc.